

User Instructions

Gas-fired condensing system appliance

Greenstar 4000

GR4700iW S



Preface

Dedicated to heating comfort.

Thank you for purchasing a Worcester product. We pride ourselves on manufacturing appliances to the strictest quality control standards throughout every stage of production.

Worcester, Bosch group has led the field in innovative product design and performance for over 50 years. This heritage means all our products are of exceptional quality and proven reliability.

Our products employ the latest technologies and they are reliable, extremely energy efficient, offering you economical running costs and value for money. They are amongst the top energy rated appliances available.

There is also the reassurance of our parts and labour guarantee. Our Customer Service team is here to help you get the best from your Worcester product throughout its lifetime. Whatever your enquiry, our specially trained team is available at our Worcester based contact centre and online via the website. For contact details see the back cover.

Table of contents

1	Explanation of symbols and safety instructions	4
1.1	Explanation of symbols	4
1.2	General safety instructions	4
2	Product Information	6
2.1	Appliance identification and serial number	6
2.2	Servicing	6
2.3	Maintaining your appliance	6
2.4	Benchmark standard	6
3	Prepare for operation	7
3.1	Sealed heating system	7
3.1.1	Checking the system pressure	7
3.1.2	Low pressure indication	7
3.1.3	Constantly re-pressurising the system	7
3.2	Topping up the system pressure	8
4	Operation	9
4.1	Control panel overview	9
4.2	Overview of keys	9
4.3	Symbols on the display	10
4.4	Adjusting the appliance flow temperature	10
4.4.1	Setting the flow temperature	10
4.5	Setting the DHW heating	10
4.6	Setting the heating control device	10
4.7	Operating the menu	11
4.8	Settings in the menu	11
5	Key (control accessories)	12
5.1	Setting the time program	12
6	Shutdown	12
6.1	Setting frost protection	12
7	Thermal disinfection (DHW cylinder only)	12
8	Clearances and ventilation information	13
8.1	Appliance clearances	13
8.2	Ventilation information	14
9	Malfunction or failure	15
9.1	Troubleshooting (fault reset)	15
9.2	Extreme cold weather	15
9.3	System gassing troubleshooting	16
10	Environmental protection and disposal	18
11	Tips on energy saving	18
12	Your guarantee	19
13	Energy consumption	20
13.1	Product data on energy consumption	20
14	Data Protection Notice	24

1 Explanation of symbols and safety instructions

1.1 Explanation of symbols

Warnings

In warnings, signal words at the beginning of a warning are used to indicate the type and seriousness of the ensuing risk if measures for minimizing danger are not taken.

The following signal words are defined and can be used in this document:

 **DANGER**
DANGER indicates that severe or life-threatening personal injury will occur.

 **WARNING**
WARNING indicates that severe to life-threatening personal injury may occur.

 **CAUTION**
CAUTION indicates that minor to medium personal injury may occur.

NOTICE
NOTICE indicates that material damage may occur.

Important information

 The info symbol indicates important information where there is no risk to people or property.

Additional symbols

Symbol	Meaning
▶	a step in an action sequence
→	a reference to a related part in the document
•	a list entry
–	a list entry (second level)

Table 1

1.2 General safety instructions

Notices for the target group

These operating instructions are intended for the heating system operator.

All instructions must be observed. Failure to comply with instructions may result in material damage and personal injury, including danger to life.

- ▶ Read and retain the operating instructions (heat source, heating controller, etc.) prior to operation.
- ▶ Observe the safety instructions and warnings.

Determined use

The product may only be used for the heating of boiler water and for DHW heating.

Any other use is considered inappropriate. We assume no liability for damage occurring due to non-permitted use.

If you smell gas

A gas leak could potentially cause an explosion. If you smell gas, observe the following rules:

- ▶ Prevent flames or sparks:
 - Do not smoke, use a lighter or strike matches.
 - Do not operate any electrical switches or unplug any equipment.
 - Do not use the telephone or ring doorbells.
- ▶ Turn off the gas at the meter or regulator.
- ▶ Open windows and doors.
- ▶ Warn your neighbours and leave the building.
- ▶ Prevent anyone from entering the building.
- ▶ Move well away from the building: call the National Gas Emergency Service on 0800 111 999.
- ▶ L.P.G. boilers: Call the supplier's number on the side of the gas tank.

Danger to life from poisoning by flue gas

There is a danger to life from escaping flue gas.

▶ Never modify any parts through which flue gas is routed.

If flues are damaged or leaking, or if you smell flue gas, observe the following rules.

- ▶ Switch off the heat source.
- ▶ Open doors and windows
- ▶ Warn your neighbours and leave the building immediately.
- ▶ Prevent third parties from entering the building.
- ▶ Notify an approved contractor.
- ▶ Have any defects rectified.

⚠ Danger to life from carbon monoxide

Carbon monoxide (CO) is a poisonous gas, which arises during the incomplete combustion of fossil fuels such as oil, gas or solid fuels.

Dangers arise, if carbon monoxide escapes from the heating system due to a fault or a leak and collects unnoticed in enclosed spaces.

You can neither see, taste nor smell carbon monoxide.

To avoid danger from carbon monoxide:

- ▶ Have the heating system inspected and serviced regularly by an approved contractor.
- ▶ Use a CO detector, which gives an alarm in good time if CO escapes.
- ▶ If you suspect a CO leak:
 - Warn your neighbours and leave the building immediately.
 - Call an approved contractor.
 - Have any defects rectified.

⚠ Inspection, cleaning and maintenance

The user is responsible for ensuring the heating system is safe and environmentally compatible.

Non-existent or improper inspection, cleaning and maintenance may result in personal injury, including danger to life or material damage.

We recommend that you enter into a contract covering an annual inspection and responsive cleaning and maintenance with an approved contractor.

- ▶ Have work carried out only by an approved contractor.
- ▶ Have the appliance and heating system inspected by an approved contractor at least once a year.
- ▶ Have any required cleaning or maintenance work carried out immediately.
- ▶ Have any defects in the appliance and heating system remedied immediately, independent of the annual inspection.

⚠ Fittings and modification

Only a competent engineer can remove the appliance case and carry out any work, in accordance with the relevant Installation Regulations.

Any misuse or unauthorised modifications to the appliance, flue or associated accessories and heating system will invalidate the guarantee.

- ▶ Do not modify the appliance or flue system in any way.

Worcester, Bosch Group accepts no liability arising from any such actions. This does not affect your statutory rights.

⚠ Combustion air/ambient air

The air in the installation location must be free of flammable or chemically aggressive substances.

- ▶ Do not store or use any flammable or explosive materials (paper, petrol, thinners, paints, etc.) in the vicinity of the heat source.
- ▶ Do not store or use any corrosive substances (solvents, adhesives, chlorinated cleaning agents, etc.) in the vicinity of the heat source.

⚠ General considerations

- ▶ The boiler must be installed in a well ventilated area. The openings must be kept in good condition.
- ▶ The vents or any other component contributing to the functioning of the boiler must not be reduced or sealed.
- ▶ We recommend an annual service of the appliance by an approved engineer to ensure reliable and efficient operation.

⚠ Safety of electrical devices for domestic use and similar purposes

The following requirements apply in accordance with EN 60335-1 in order to prevent hazards from occurring when using electrical appliances:

“This appliance can be used by children of 8 years and older, as well as by people with reduced physical, sensory or mental capabilities or lacking in experience and knowledge, if they are supervised and have been given instruction in the safe use of the appliance and understand the resulting dangers. Children shall not play with the appliance. Cleaning and user maintenance must not be performed by children without supervision.”

“If the power cable is damaged, it must be replaced by the manufacturer, its customer service department or a similarly qualified person, so that risks are avoided.”

⚠ Please read these instructions carefully

- ▶ These instructions are applicable to the Worcester appliance model/s stated on the front cover only.
- ▶ These instructions apply in the UK/IE only and must be followed except for any statutory obligation.

2 Product Information

2.1 Appliance identification and serial number

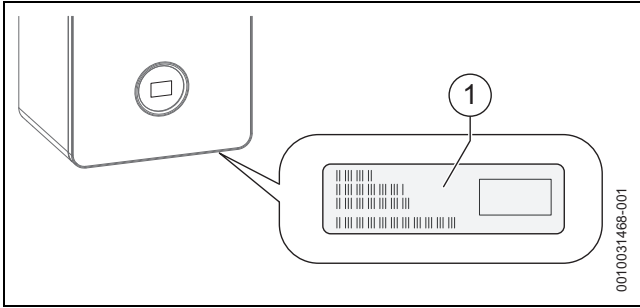

Fig. 1 Position of data label

The data label [1] contains information of the appliance model and serial number. This is located centrally on the bottom of the appliance in line with the control panel.

For your own records

Please ensure that the Commissioning Checklist has been completed by your installer or service engineer.

Model:	
Serial number:	
Date of installation:	

Table 2 Appliance details

The appliance model and serial number can be found on the appliance data label.

2.2 Servicing



Ensure that the service engineer completes the Service Record in the Benchmark Checklist after each service.

The Service Record can be found at the rear of the appliance's Installation and Maintenance Instructions. It will be required in the event of any guarantee work and may be required by the local Building Control Inspector.

- ▶ To ensure the continued safe, reliable and environmentally optimum operation of the boiler, it must be thoroughly serviced annually by a competent, qualified person, such as a Worcester service engineer, British Gas engineer or other Gas Safe registered engineer. In the Republic of Ireland servicing work must be carried out by a Worcester service engineer or other Registered Gas Installer (RGI).
- Having a contract covering annual servicing, cleaning and maintenance is a good way to ensure this is not missed.
- It is important that any required maintenance or repairs are carried out without delay.
- ▶ Ensure that the service engineer completes the Service Record, at the rear of the Installation and Maintenance Instructions manual, after each service.
- ▶ Have any work carried out by a competent, qualified person, Worcester service engineer, British Gas engineer or other Gas Safe registered engineer. In the Republic of Ireland servicing work must be carried out by a Worcester service engineer or other Registered Gas Installer (RGI).
- ▶ Always use original spares, to help maintain the efficiency, safety and reliability of the appliance.

2.3 Maintaining your appliance

Your new appliance represents a long term investment in a reliable, high quality product.

Wipe the appliance casing with a soft clean cloth. Please do not use chemical cleaning products which may damage the paint finish.

In order to realise the appliance's maximum working life, and to ensure the appliance continues to operate at peak efficiency and performance, it is essential that servicing and maintenance checks are performed at least once a year by a competent engineer in accordance with the current Gas Safe Regulations.

If you would like to know more about servicing options from Worcester, Bosch Group, please visit worcester-bosch.co.uk.

Please tick the appropriate box on your warranty registration card for further details of the Worcester, Bosch Group Service Contract.

When your appliance requires servicing please contact a Worcester, Bosch Group contact centre (see rear cover, appointments).

In addition to the service contract we are pleased to offer a one-off annual service or breakdown call out for your appliance.

Maintenance tips

- Appliances on a sealed heating system:
 - Regularly check the system pressure.
- Do not obstruct the flue outlet or the air inlet.
- Use in hard water areas:
 - In exceptionally hard water areas a device to prevent scale formation may be fitted. Installation of a salt based water softener should be in accordance with the requirements of the local water company. A bypass valve must be fitted and used to fill/top up the heating system with untreated water.



Important note:

- ▶ If you have to add water regularly in your heating system, call a competent, qualified person.

2.4 Benchmark standard



The Benchmark initiative is a code of practice to encourage the correct installation, commissioning and servicing of domestic central heating appliances and system equipment.

A "checklist" is dispatched with every appliance and can be found towards the back of the Installation, Commissioning and Servicing Instructions. This is a vital document that needs to be completed by the installer at the time of installation. It confirms that the appliance has been installed and commissioned according to the manufacturer's instructions.

The service record provides space for the recording of regular servicing of the appliance/heating system and this can become a valuable document when, for example, you wish to sell the property. The service record will show a potential purchaser that the heating system has received regular professional maintenance and servicing during its lifetime.

The Benchmark initiative aims to:

- Raise standards among professional installers.
- Build and maintain high safety standards in the industry.
- Improve customer satisfaction levels.
- Make a contribution to the nation's commitment to climate change.

3 Prepare for operation

3.1 Sealed heating system

Appliances that can be connected to sealed heating systems are pre-pressurised before operation, this pressure must be maintained for safe use of the appliance.

- ▶ Check regularly that the pressure is maintained.
- ▶ Re-charge the system if the pressure indicator reads less than 0.8 bar.
- ▶ If a permanent significant decrease or increase in pressure is shown on the pressure indicator, contact your installer or maintenance engineer.



Pressure indicator

- ▶ Type of pressure indicator for the system pressure.
 - Pressure gauge (an analogue dial showing the pressure)
 - Pressure menu (a digital readout of the pressure)
- ▶ Your appliance may have one or both types of methods to indicate the system pressure. The type of method used on this appliance will be detailed in the following section.

3.1.1 Checking the system pressure

The appliance pressure menu indicates the pressure within the heating system during standby and operating periods.

Your installer will advise you of the optimum operating pressure.

- ▶ Check the system pressure on the pressure menu.
 - **Static pressure** is when appliance is cold and has not fired for heating or hot water. This will generally be 0.8 - 1.7 bar.
 - **Operating pressure** is when the appliance is firing for a heating or hot water demand. This will generally be 1 - 2 bar.

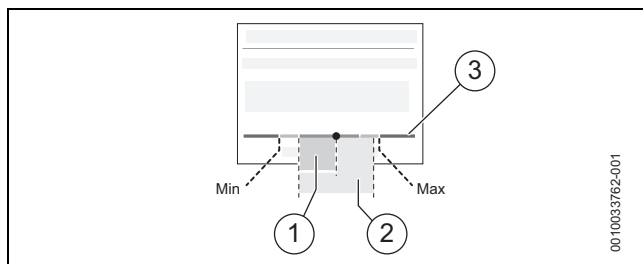

Fig. 2 Checking the operating pressure

- [1] Static pressure range.
- [2] Operating pressure range.
- [3] Pressure menu indicator.

The pressure menu can be accessed via the **Boiler status** screen.

- ▶ Press the menu key (≡). Select and confirm **Boiler status**. The screen **Boiler status** with a pressure menu indicator appears.
- ▶ Check the system pressure on the display.
 - **Indicator in red zone:** pressure is too low or too high.
 - **Indicator in yellow zone:** pressure is low or slightly too high.
 - **Indicator in green zone:** pressure is normal.
- ▶ Top up the heating water, if the pressure is low or too low.

3.1.2 Low pressure indication

Low pressure (shaded area [A]) will be indicated on the appliance:

- The pressure indicator is within the area between 0 and 0.79 bar in the pressure menu display (left hand yellow and red zone).
- Additionally there is a message displayed.

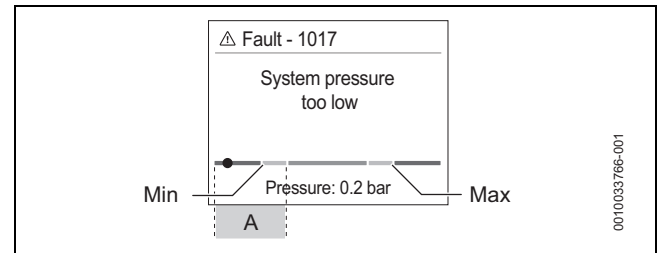

Fig. 3 Low pressure indication

[A] Low pressure area

3.1.3 Constantly re-pressurising the system

Constantly having to re-pressurise the heating system should be investigated as it is an indicator of potential leaks and the concentration of inhibitor protection in the system will be reduced; this can result in corrosion within the heating system, reducing efficiency and increasing contaminates.

- ▶ Check for leaks on heating system (pipework and radiator valves).
- ▶ Contact your installer or maintenance engineer if a recurring significant decrease or increase in pressure is indicated on the pressure screen.

System pressure increasing:

- ▶ If the system pressure repeatedly increases and you need to vent air from the radiators, refer to → section 9.3 "System gassing troubleshooting", page 16.

3.2 Topping up the system pressure

To aid in filling the system.

- ▶ Ensure the Central Heating is on.

Removal and replacement of bottom panel

To gain access to the filling link, remove the bottom panel.

Press in the tabs [A] and pull the bottom panel down to remove.

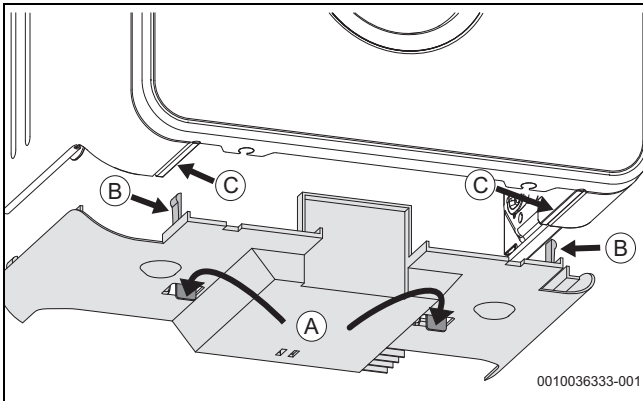

Fig. 4 Bottom panel

To replace the bottom panel, ensure that the tabs [B] line up with the edges of the boiler [C] and push into place until the tabs [A] click into place.

External filling loop

Once the external filling loop and pressure menu has been located, follow the instructions for re-pressurising the system.

Refer to figure 5.

- ▶ Unscrew the blanking cap [1].
 - ▶ Attach the hose [2] to the valve.
 - Usually one end of the hose is already connected to one of the system fill isolation valves.
 - ▶ Ensure both ends [3] of the hose are screwed on hand tight.
 - ▶ Monitor the pressure menu.
 - The system fill isolation valves [4] are in a closed position (the handle/screwdriver slot is across the valve).
 - ▶ Turn the handle/screwdriver slot through 90° to open valves and slowly fill the system.
 - The system fill isolation valves [5] are opened (the handle/screwdriver slot is in-line with the valve).
 - The pressure menu indicator moves and the displayed message may change [6].
 - ▶ Turn the handles/screwdriver slots back, through 90°, to close the valves when the:
 - The pressure menu reads OK and the pressure menu indicator is in the green zone [8].
- The system fill isolation valves [7] are in a closed position (the handle/screwdriver slot is across the valve).
- ▶ Top up the system pressure, if as a result of the air bleeding the pressure drops off.
 - ▶ Remove the hose [2] and replace the blanking cap [1].

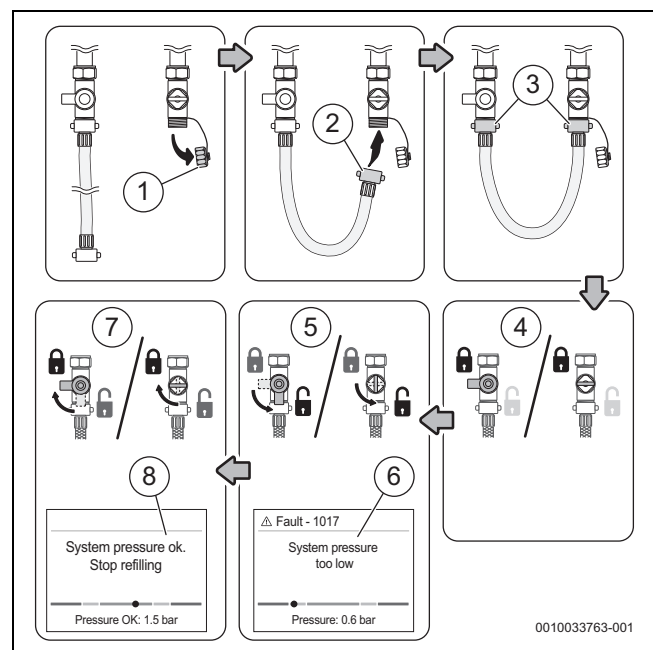

Fig. 5 External filling loop



If the pressure gauge reads more than 1.7 bar as a result of over filling:

- ▶ Bleed one radiator until the pressure gauge returns to between 1 and 1.7 bar.
- ▶ It is good practice to bleed any excess air that has entered the heating system due to pressure loss. Locate and open the radiator's bleed/vent point, closing the valve when water begins to flow.
- ▶ If, through normal boiler operation, the PRV pipe starts to leak, it could be a sign of system pressure being too high. In this instance please bleed a radiator as described above.

4 Operation

These operating instructions describe the operation of the gas-fired condensing boiler. Therefore please also observe the operating instructions for the user interface.

4.1 Control panel overview

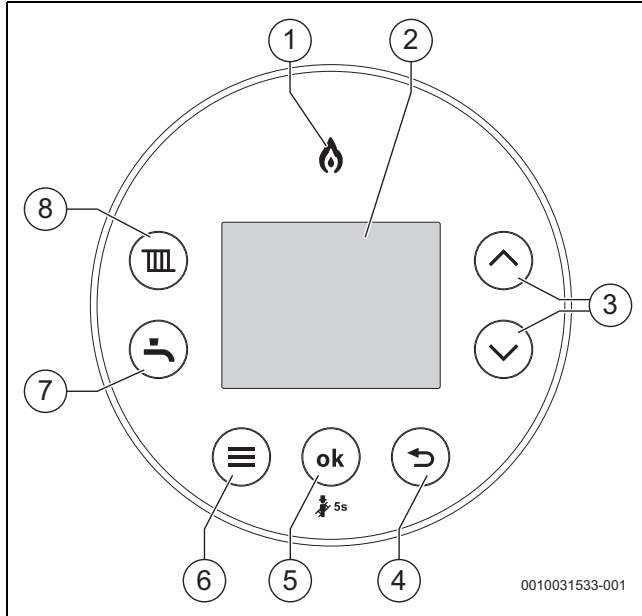

Fig. 6 Overview

- [1] Burner display: Illuminates when the burner is alight.
- [2] Display.
- [3] ▲ and ▼ buttons: To navigate through menus and increase/decrease settings.
- [4] ↶ button: Return/back.
- [5] **ok** button: Selection/save settings.
- [6] Menu button.
- [7] Hot water button: Hot water mode on/off, adjusting the hot water temperature.
- [8] Heating button: Heating mode on/off, set the maximum flow temperature.

4.2 Overview of keys

Key	Function
	Heating <ul style="list-style-type: none"> • Heating mode
	Domestic Hot Water (DHW) <ul style="list-style-type: none"> • DHW mode
	Menu <ul style="list-style-type: none"> • Access to menus
ok	Select/save <ul style="list-style-type: none"> • Confirm a selection • Save setting • DHW eco/preheat
	Back arrow <ul style="list-style-type: none"> • Exit menu (without saving changes)
	Up arrow <ul style="list-style-type: none"> • Menu navigation • Increase values
	Down arrow <ul style="list-style-type: none"> • Menu navigation • Reduce values

Table 3 Overview of keys

4.3 Symbols on the display

Symbol	Explanation
	Connection with the Wi-Fi network (only available with accessories)
	Connection with Radio Frequency (RF) transmitter, e.g. Comfort+ I RF room thermostat (only available with Key accessories)
	Central heating adjustment ¹⁾ On: Heating is on. auto: Heating is switched on and off according to programmed times for heating. Once: Move to the next on or off time and directly switch on or off heating. Off: Heating is off.
	Central heating off
	Domestic Hot water adjustment ²⁾ On: Hot water preheat is on auto ¹⁾ : Hot water is switched on and off according to programmed times for hot water. Once ¹⁾ : Hot water heating on, from the first programmed switched-on time to the last programmed switch-off time. Off (eco): Hot water preheat off (boiler in eco mode)
	Hot water off
	Displays with the appliance status code and diagnostic code during a fault condition.
	Cleaning mode, locks the screen for 15 seconds to enable cleaning.
	Central heating or hot water can be switched either permanently on or off.
	Energy consumption ³⁾ - Gas consumption kWh

- 1) This feature is available the timer Key accessories
- 2) Domestic Hot Water temperature and adjustment is only available if an optional integral diverter valve kit is fitted
- 3) The displayed energy values are estimated based on the internal data of the appliance. Under real conditions many factors influence the energy consumption and the displayed energy values differ from the energy values of an energy meter. The energy values are for information and should not be used for billing purposes. The energy values can be used to compare the energy consumption between different days / weeks / months.

Table 4 Symbols on the display

i The heating and hot water system has been set up by the installer to its optimum settings.

- ▶ It is advised to make a note of these settings before adjusting so that you can return to these optimum settings in the future.

4.4 Adjusting the appliance flow temperature

4.4.1 Setting the flow temperature

i With underfloor heating systems observe the maximum permissible flow temperature.

The maximum flow temperature can be adjusted between 30 °C and 82 °C ¹⁾.

- ▶ Press the key. The set maximum flow temperature appears.
- ▶ Press the or keys to set the desired maximum flow temperature.

Flow temperature	Sample application
Approx. 50 °C	Underfloor heating system
Approx. 70 °C ¹⁾	Radiator heating system

1) In certain cases, for example, where radiators are undersized or homes are poorly insulated higher flow temperatures may be required, however, please refer to the relevant scalding risk advice in this manual.

Table 5 Maximum flow temperature

- ▶ The setting is saved automatically after two seconds. Then the symbol is briefly displayed.

Heating On/Off

- ▶ Press the key. The set maximum flow temperature appears.
- ▶ Where a Comfort+ or Comfort+ I RF timer key is fitted the Central Heating can be turned on with the **ok** key during an off period

4.5 Setting the DHW heating

i Hot water functions are only available when an optional integral diverter valve kit is fitted.

Setting the DHW temperature

- ▶ Press the key. The set DHW temperature appears.
- ▶ To set the desired DHW temperature, press the or keys.
- ▶ The setting is saved automatically after two seconds. Then the symbol is briefly displayed.

Hot water mode

The hot water temperature can be set between 35 °C and 60 °C.

- ▶ Press the key. The set hot water temperature appears.
- ▶ To set the desired hot water temperature, press the or keys. The setting will be saved after 5s or after pressing the **ok** key.

eco key

In **eco** mode the appliance will heat the cylinder if the temperature is approximately 12 °C below the set temperature. Eco mode is enabled by default, during the initial appliance start up.

In **Preheat** mode the appliance will heat the cylinder if the temperature is approximately 6 °C below the set temperature. The appliance heats the cylinder more frequently. This tops up the cylinder temperature for quicker heat up times, this is useful for large/longer demand periods.

4.6 Setting the heating control device

i Observe the operating instructions of the heating controller. This shows you:

- ▶ how to set the room temperature.
- ▶ how to heat economically and save energy.

1) The maximum value can be reduced by the service technician.

Heating/DHW via time program (Key control accessories)





Time programs are available with Key control accessories fitted. If a time program is available and the heating/DHW mode is set on **Auto** press the **ok** key to select **Once**.

Auto: Heating/DHW mode is switched on and off according to programmed times.

Once: Switch to **Once** to move to the next central heating/DHW on or off time.

4.7 Operating the menu





Opening and closing the menu

- ▶ To open the menu, press the  key.
- ▶ To exit the menu, press the  key again.

-or-

- ▶ Press the  key.

Changing the setting values

- ▶ To highlight a menu item, press the  key or the  key.
- ▶ Select the menu item with the **ok** key.
- ▶ To change the value, press the  or  key.
- ▶ Press the **ok** key.
The new value is saved.

Exiting the menu without saving values

- ▶ Press the  key.

4.8 Settings in the menu



The factory settings are **highlighted** in the following table.

Menu item	Function definition
Heating mode ¹⁾	<ul style="list-style-type: none"> • On • Auto: Activate time program. • Once: Heating is on from the first programmed on time to the last programmed off time without off periods. • Off
Heat. time prog. ¹⁾	Timer for heating: Weekday(s) selection, day program and timer adjustment (→ 5.1 "Setting the time program", page 12) ¹⁾
DHW operation ²⁾	<ul style="list-style-type: none"> • On • Auto¹⁾: Activate time program. • Once¹⁾: Heating the cylinder is on from the first programmed on time to the last programmed off time without programmed intermissions.
Eco/Preheat	<ul style="list-style-type: none"> • Eco: Appliance will heat the cylinder if the temperature falls approximately 10°C below the set temperature for hot water. • Preheat: Appliance will heat the cylinder if the temperature is approximately 5°C below the set temperature for hot water.
DHW time prog. ¹⁾	Timer for hot water: Weekday(s) selection, day program and timer adjustment (→ 5.1 "Setting the time program", page 12).
Boiler status	Current system values including the pressure indicator.

Menu item	Function definition
Information	The current system values and the active operating conditions can be called up in the Information menu. Changes are not possible. <ul style="list-style-type: none"> • System pressure • Hot water Temp. (DHW temperature reading shown when the diverter valve kit is fitted. If not fitted, the menu will correctly display "----") • Weather comp. (where fitted) • Key (Type of installed Key is shown e.g. "Comfort + RF key")
Energy consump.	Display Gas consumption <ul style="list-style-type: none"> • Last 24h • Last 30 days
Settings	<ul style="list-style-type: none"> • Time: Set the current time.¹⁾ • Date: Set the current date.¹⁾ • Parental lock <ul style="list-style-type: none"> – On – Off • Display <ul style="list-style-type: none"> – Switch off after: Set the time after which the display is switched off. – Brightness: Set the display brightness. • Key illum. • Language: Change the language of the menu and the menu items. • Units¹⁾
Cleaning funct.	Boiler keypad is disabled for 15 seconds.
Emergency mode ³⁾	<ul style="list-style-type: none"> • On: Set the desired heating flow temperature by pressing back or menu key after selecting On. • Off

1) Only available with installed Key (accessories)

2) Domestic Hot Water temperature and adjustment is only available if an optional integral diverter valve kit is fitted

3) Allows manual control of heating during loss of Radio Frequency (RF) Key signal

Table 6 Settings Menu

5 Key (control accessories)

Key LED status

The LED on the Key displays different states with flashing or constant colours.



Description of the LED displays	Example
Flashing red: Fault, e.g. no communication between the Key and appliance: ► Install the Key again, restore the last functioning status.	
Flashing yellow: No fault, user please wait.	
Flashing green: No fault, initialisation process is running.	
Constant red: Temporary fault: ► Wait for normal operating condition to be resumed.	
Constant yellow: No fault, time and date not available: ► Set the time and date on the appliance. -or- ► Key with touch-sensitive indicator: Press touch-sensitive indicator on Key to start pairing.	
Constant green: No fault, normal operating condition.	
LED Off: No fault, power-saving mode or appliance without power.	

Table 7 LED status

5.1 Setting the time program



Time program



The same method for setting the time program for heating is used to set the time program for hot water.

- Press the  key.
- Select and confirm the **Heat. time prog.** or **DHW time prog.** menu.
- Select and confirm the **Time program** menu.
The menu items **Mon - Fri, Sat - Sun, Mon ... Sun** are displayed.

Possible items to change:

- **Mon - Fri** to change switching times for all weekdays together
- **Mon ... Sun** to change switching times for individual days
- **Sat - Sun** to change switching times for weekends
- Select and confirm item you want to change.
- Select and confirm time entry you want to change.
- To change the time, press the  or  key.
- Press the **ok** key.
The new time is saved. Next time entry is selected.



Add one additional switching time block by selecting **+**. Delete an existing switching time block by selecting .

6 Shutdown

6.1 Setting frost protection

NOTICE

Risk of damage to the system from frost!

The heating system can freeze up after a prolonged period (e.g. during a power failure, switching off the power supply, faulty fuel supply, boiler fault etc.).

- Ensure that the heating system is in constant use (particularly when there is a risk of frost).

If you are leaving your property unoccupied during cold weather, please leave your external programmer on constant and your room thermostat set to 12 °C.

7 Thermal disinfection (DHW cylinder only)

To prevent hot water from becoming contaminated by bacteria such as legionella, we recommend thermal disinfection after long downtimes. You should have a qualified engineer carry out thermal disinfection.

8 Clearances and ventilation information

8.1 Appliance clearances

Your installer will have provided adequate space around the appliance for operation, safety and servicing/maintenance access.

- The following detail the necessary clearance around the appliance for service and maintenance.

CAUTION

Risk of damage to appliance or property

The appliance will overheat if the clearance space around the appliance is restricted by objects.

- Do not restrict this space with the addition of cupboards, shelves etc. next to or around the appliance.
- Do not store any combustible materials on or next to the appliance, such as clothes, towels, paper or plastic bags.

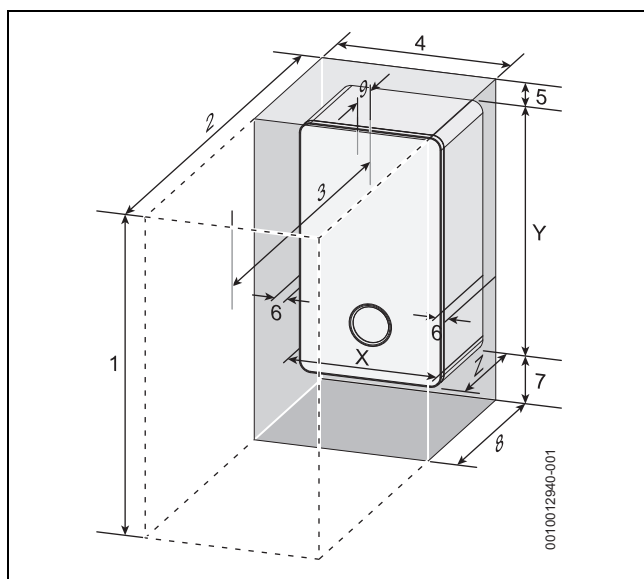

Fig. 7 Appliance minimum clearances

Minimum clearance		
	Description	Dimensions (mm)
X	Appliance width	400
Y	Appliance height	724 ¹⁾
Z	Appliance depth	310
Maintenance		
1	Overall clearance height	1,080/1,120 ²⁾
2	Overall clearance depth	760/910 ³⁾
3	In front of appliance	450/600 ³⁾
4	Overall clearance width	410
5	Above the appliance	170/210 ²⁾
6	Either side of appliance	5
7	Below the appliance	186
8	Compartment depth	330
9	Appliance to removable door	20

- 724mm to middle of top panel.
710mm side panel height.
Bottom panel is removable and not part of minimum clearance height requirements.
- Height for either 60/100 flue or 80/125 flue
- Front clearance can be reduced by 150mm, refer to the advice given in Reduced front maintenance minimum clearances.

Table 8 Appliance minimum clearances

Reduced front maintenance minimum clearances

The front servicing clearance for this appliance can be reduced to 450mm.

For installations with a front servicing clearance less than 600mm (minimum of 450mm), the following additional criteria must be achieved.

- The bottom of the appliance case must be between 1000mm and 1500mm from the floor.
- There must be at least 450mm clearance in front of the appliance to floor level. Anything sited below the appliance must not protrude into this clear space.
- There must be at least 186mm clearance to any structure which is sited below the appliance.
- There must be at least 300mm clear space to either the left hand or right hand side of the appliance. This clear space must be from the required clear height above the appliance to floor level.
 - This clearance will not apply if the appliance is sited within 300mm of a door way and the door frame is the only obstruction.



Minimum clearances must be observed to any obstruction/ surface, (dark shaded areas, figures 8 and 9).

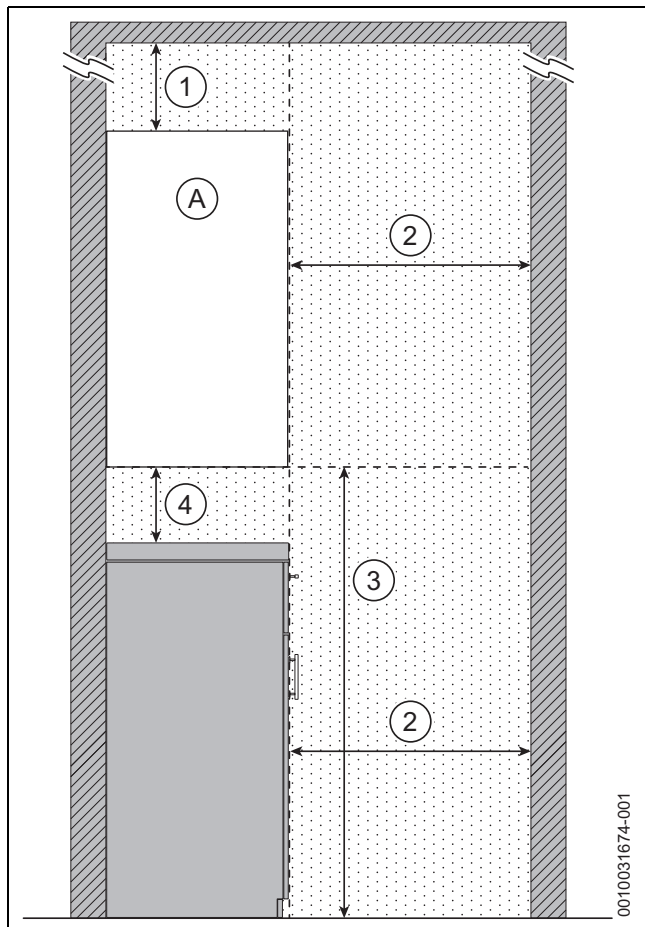

Fig. 8 Reduced front maintenance clearances - Side view

- [A] Appliance.
- [1] Above appliance - Same clearance required as for standard clearances of 60/100 flue or 80/125mm flue.
- [2] In front of appliance - Minimum 450mm.
- [3] Bottom of appliance to the floor - 1,000 - 1,500mm.
- [4] Below appliance - 186mm

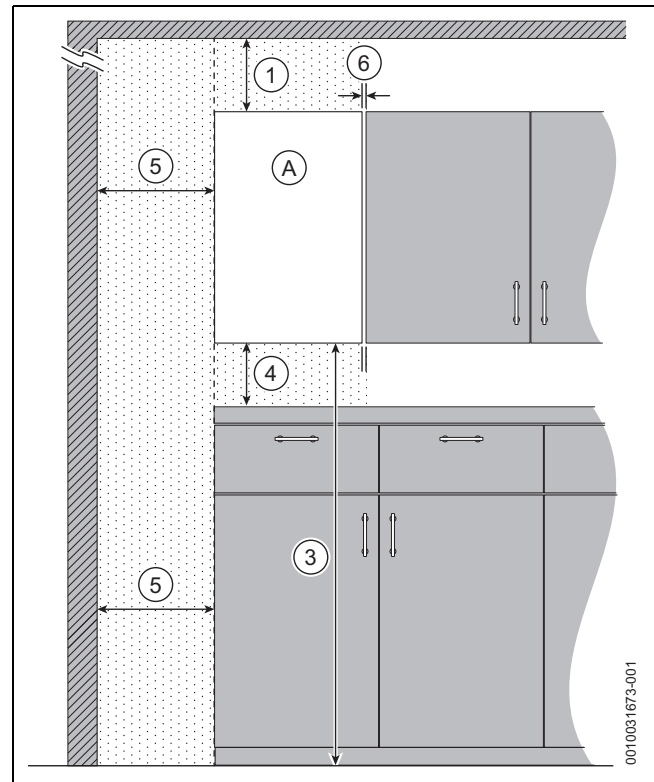

Fig. 9 Reduced front maintenance clearances - Front view

- [A] Appliance.
- [1] Above appliance - Same clearance required as for standard clearances of 60/100 flue or 80/125mm flue.
- [3] Bottom of appliance to the floor - 1,000 - 1,500mm.
- [4] Below appliance - 186mm
- [5] One side of appliance - Minimum 300mm.
- [6] One side of appliance - Minimum 5mm.

8.2 Ventilation information

The air supply must not be restricted or contaminated.



Ventilation considerations

- ▶ Do not place objects to hinder the air circulation required by the appliance.
- ▶ The installation premises may require ventilation to be fitted according to its features or use.

9 Malfunction or failure

If you believe there is a problem with your central heating or hot water supply, before you contact your installer/maintenance engineer and report the error and appliance type carry out the following checks.

Basic checks

Some items to check before placing a call are:

- Is the electrical power switched on to the appliance?
- Is the programmer/timer set to ON or in an ON period?
- Is the room thermostat set too low?
- Is the cylinder thermostat (if fitted) set too low?
- Is the cold water main turned on?
- Sealed heating system:
 - Is the static system pressure (when appliance is cold) between 1 and 1.5 bar?
- Do you have gas?
 - Are other gas appliances working, gas cooker/hob for example?
 - Has your credit run out on your gas pre-payment meter?

Details of your installer should be available in the Commissioning Checklist or can be recorded in the following section.

Installer/maintenance engineer

Installer/maintenance engineer details	
Engineer name:	
Company name:	
Company address:	
Telephone:	
Email:	

Table 9

Worcester, Bosch Group

The appliance is supported in the UK and Eire by Worcester, Bosch Group.

Specialist service engineers are available to attend an appliance breakdown.



Invoices for attendance and repair work carried out on this appliance by any third party will not be accepted.

- No charge will be made for parts and/or labour providing:
 - The appliance fault is found and the appliance is within the guarantee period. Reasonable evidence of this must be supplied on request. i.e. a completed Commissioning and service record and has been regularly serviced at least once a year.
- A call-out charge will be made where:
 - The appliance is outside the guarantee period or has not been serviced in accordance with the manufacturers instructions.
 - Our Field Service Engineer finds no fault with the appliance.
 - The cause of breakdown is misuse or with other parts of your plumbing/heating system, or with equipment not supplied by Worcester, Bosch Group.



No appliance fault is found on over 30% of all service calls.

- ▶ In the case of a suspected fault, refer to the basic checks earlier in this section.

In the event of an appliance fault or breakdown please contact Worcester, Bosch Group appointments team on 0330 123 9339. Your advisor will arrange for an engineer to call with the minimum of delay; under normal circumstances this will be from 1–3 working days (excluding weekends and bank holidays) for priority breakdown situations (no hot water and/or heating).

9.1 Troubleshooting (fault reset)

If there is fault in the system, there will be a message shown on the display with an icon on the right up corner. The color of this icon depends on the severity of the fault in the system. The cause of the fault is coded (e.g. fault code 232) and displayed as text.

- ▶ Press the ▲ and ▼ keys until **Reset** is displayed. The appliance starts up again and the current supply temperature is displayed.

If a fault persists:

- ▶ Contact the contractor or the customer service.
- ▶ Provide them with the displayed fault code and the device data (→ table 6).

9.2 Extreme cold weather

In certain instances where the condensate pipe work is run externally or in an unheated area, such as a garage, the condensate pipe work can be at risk of freezing, even if well insulated.

A frozen/blocked condensate pipe will cause the boiler to shut down. Worcester, Bosch Group have available helpful videos on thawing frozen condensate pipe work on our website in the Customer service section.



WARNING

Falling hazard!

Failure to follow this guidance may result in personal injury.

- ▶ Only attempt to thaw a condensate pipe that is at ground level and easily accessible.
- ▶ Never attempt to thaw a condensate pipe that is at height.



CAUTION

Risk of damage to pipe work!

Thermal shock from boiling water can damage plastic pipes.

- ▶ **DO NOT** use boiling water to thaw the condensate pipe!



CAUTION

Slip hazard

- ▶ Ensure that the subsequent freezing of any water does not result in a slip hazard.

If the condensate pipe has frozen:

- ▶ Locate the blockage.
 - It is likely that the pipe is frozen at the most exposed point outside the building or where there is an obstruction to flow. This could be the open end of the pipe, at a bend or elbow, or where there is a sag in the pipe in which condensate can collect.
 - The location of the blockage should be identified as closely as possible before taking further action.

- ▶ Thaw the frozen pipe.
 - The pipe can be thawed by applying a hot water bottle, a microwaveable heating pack (the sort used for muscular aches and pains) or a cloth soaked in hot water to the exterior of the pipe, close to the point of blockage.
 - Hot water, but not boiling, can also be poured onto the pipe from a watering can or similar container.
 - Care must be taken at pedestrian areas where this water may freeze and create a slip hazard.
- ▶ Worcester, Bosch Group have available on our website helpful videos in the Customer service section to aid in thawing a frozen pipe.
- ▶ Reset the appliance and wait two or three minutes for the appliance to restart.
- ▶ Contact Worcester, Bosch Group Appointments Team on: 0330 123 9339, if the boiler does not restart.
- ▶ Contact your installer in order to find a permanent solution to the problem.

9.3 System gassing troubleshooting



WARNING

Caution must be exercised when venting radiators or adjusting system pressure after commissioning of your boiler.

Do not repeatedly vent your radiators, if symptoms persist, contact a heating engineer.

- ▶ Do not vent air from radiators whilst the central heating is switched on; turn your boiler off.
- ▶ Whilst venting radiators, do not allow the pressure on the boiler to drop below the pressure at which it is normally set.



CAUTION

If the pressure in your heating system is repeatedly rising (this can be checked via the boilers pressure gauge or digital display and should be checked when the system is cold), and especially if you need to keep venting the radiators, urgent action is required and you must contact a heating engineer. This can indicate that there is corrosion occurring within the heating system

Note: Ensure the reading stays between minimum and maximum operating pressures at all times whilst the boiler is operating

- ▶ This must be properly addressed to prevent serious damage to the entire system.
- ▶ Failure to properly maintain the heating system may affect your warranty.

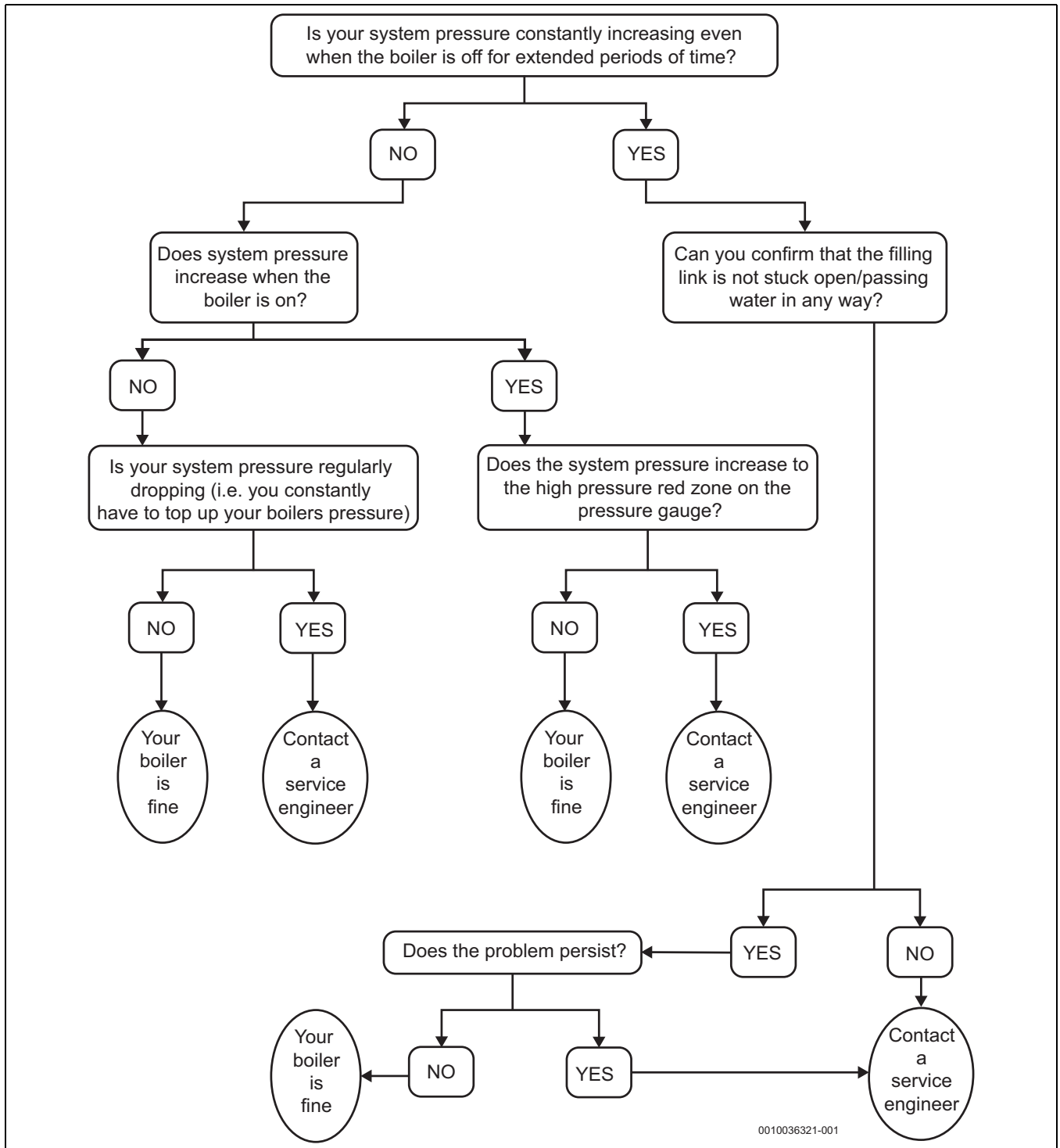

Fig. 10 Gassing flow chart

10 Environmental protection and disposal

Environmental protection is a fundamental corporate strategy of the Bosch Group.

The quality of our products, their economy and environmental safety are all of equal importance to us and all environmental protection legislation and regulations are strictly observed.

We use the best possible technology and materials for protecting the environment taking account of economic considerations.

Packaging

Where packaging is concerned, we participate in country-specific recycling processes that ensure optimum recycling.

Compostable packaging

Compostable packaging is used wherever possible in an effort to reduce the product's impact on the environment and the overall demand for plastic packaging. Where the following symbol is shown the material is compostable:



Compostable packaging can be disposed of in a number of ways:

- Home compost heap
- Local Authority garden waste collection
- Local Authority food waste collection, ideally as a food waste bin bag
- Local Authority household waste

Please note that compostable materials **cannot be recycled**.



Used appliances

Used appliances contain valuable materials that can be recycled. The various assemblies can be easily dismantled. Synthetic materials are marked accordingly. Assemblies can therefore be sorted by composition and passed on for recycling or disposal.

Old electrical and electronic appliances



This symbol means that the product must not be disposed of with other waste, and instead must be taken to the waste collection points for treatment, collection, recycling and disposal.

The symbol is valid in countries where waste electrical and electronic equipment regulations apply, e.g. "European Directive 2012/19/EC on old electronic and electrical appliances". These regulations define the framework for the return and recycling of old electronic appliances that apply in each country.

As electronic devices may contain hazardous substances, it needs to be recycled responsibly in order to minimize any potential harm to the environment and human health. Furthermore, recycling of electronic scrap helps preserve natural resources.

For additional information on the environmentally compatible disposal of old electrical and electronic appliances, please contact the relevant local authorities, your household waste disposal service or the retailer where you purchased the product.

You can find more information here:

www.weee.bosch-thermotechnology.com/

Batteries

Batteries must not be disposed together with your household waste. Used batteries must be disposed of in local collection systems.

11 Tips on energy saving

Heating economically

The appliance provides a high level of comfort whilst keeping fuel consumption and the environment effects as low as possible.

The appliance is controlled in such a way that it delivers heat at the correct rate and only if there is a clear demand from the system.

Central heating systems with thermostatic radiator valves

With modern heating systems set around a 20 °C heat loss, the optimum setting for a condensing boiler will be approximately 65 °C for the central heating temperature. This is to ensure a return temperature of less than 52 °C.

The system must be balanced correctly and the radiators may need upgrading. This allows the boiler to condense as much as possible for the central heating system.

The temperature of each room can be set individually (except primary room with the room thermostat) using the thermostatic radiator valves.

Room thermostats

Reducing the setting of the room thermostat by 1 °C can reduce fuel consumption by up to 10%.

New control systems

Upgrade your heating control system if necessary with the latest equipment available.

Roof insulation

Around 30% of the heat loss from a property is through the roof. Replace any old insulation with new insulation, preferably of around 200mm thickness or more.

Window frames

Single glazed windows, particularly those with steel frames, can lose a great deal of heat. Consideration should be given to replacement with PVCu or wooden framed double glazed units.

Radiators

If a radiator is sited underneath a window, its performance will be affected if the curtains are allowed to drape over the radiator. Shelves fitted above or in front of the radiator should also be avoided.

It is advisable to manually adjust all thermostatic radiator valves every 2–3 months to prevent them sticking. Ensure radiator valves are correctly set and not damaged.

Draughts

Try to ensure that draughts around doors, windows, letter boxes and keyholes etc. are reduced by using a suitable draught excluder.



WARNING

Air vents!

- ▶ Do not block or seal any air vents that are installed to ensure that the appliance operates safely.

Curtains

Lined curtains, or heavier full length curtains can provide excellent insulation. However, always ensure that the curtains do not drape over radiators.

12 Your guarantee

This appliance has a guarantee against faulty materials or workmanship from the date of installation subject to the following terms and conditions:

- During the period of this guarantee any components of the appliance that are proven to be faulty or defective in manufacture will be exchanged or repaired free of charge by Bosch Thermotechnology Ltd.
- The householder may be asked to prove the date of installation, that the appliance was correctly commissioned and, where appropriate, serviced to the satisfaction of Bosch Thermotechnology Ltd. These should be documented in the commissioning and service records in the Installation and Maintenance Instructions.
- The appliance has been used only for the normal domestic purposes for which it was designed.

This guarantee does not affect your statutory rights.

Guarantee registration

Your appliance/product carries a guarantee against faulty material or manufacture subject to Terms and Conditions.

To read the full Terms & Conditions please visit us on-line at www.worcester-bosch.co.uk/guarantee.

Your statutory rights are not affected by the manufacturer's guarantee

13 Energy consumption

13.1 Product data on energy consumption

Natural Gas appliance

The following product data comply with the requirements of the EU Regulations No. 811/2013, No. 812/2013, No. 813/2013 and No. 814/2013 supplementing the Regulation (EU) 2017/1369.

Product data	Symbol	Unit	7 733 600 385	7 733 600 383	7 733 600 381
Product type	–	–	GR4700iW 24 S NG	GR4700iW 21 S NG	GR4700iW 18 S NG
Condensing boiler	–	–	✓	✓	✓
Low temperature boiler	–	–	✗	✗	✗
B1 boiler	–	–	✗	✗	✗
Cogeneration space heater	–	–	✗	✗	✗
Equipped with a supplementary heater?	–	–	–	–	–
Combination heater	–	–	✗	✗	✗
Rated heat output	P_{rated}	kW	24	21	18
Seasonal space heating energy efficiency	η_s	%	94	94	94
Energy Efficiency Class	–	–	A	A	A
Useful heat output					
At rated heat output and high temperature regime ¹⁾	P_4	kW	24	21	18
At 30 % of rated heat output and low temperature regime ²⁾	P_1	kW	8.1	7.1	6.1
Useful efficiency					
At rated heat output and high temperature regime ¹⁾	η_4	%	87.9	88.2	88.1
At 30 % of rated heat output and low temperature regime ²⁾	η_1	%	98.9	99	99.1
Auxiliary electricity consumption					
At full load	e_{max}	kW	0.038	0.030	0.027
At part load	e_{min}	kW	0.012	0.011	0.011
In standby mode	P_{SB}	kW	0.002	0.002	0.002
Other items					
Standby heat loss	P_{stby}	kW	0.059	0.059	0.059
Ignition burner power consumption	P_{ign}	kW	–	–	–
Emissions of nitrogen oxides (only gas- or oil fired)	NO_x	mg/kWh	40	35	37
Annual energy consumption	Q_{HE}	kWh	20556	18056	15287
Annual energy consumption	Q_{HE}	GJ	74	65	55
Sound power level, indoors	L_{WA}	dB	45	44	45

1) High-temperature regime means 60 °C return temperature at heater inlet and 80 °C feed temperature at heater outlet.

2) Low temperature means for condensing boilers 30 °C, for low-temperature boilers 37 °C and for other heaters 50 °C return temperature (at heater inlet).

Table 10 Product data on energy consumption Greenstar 4000

The following product data comply with the requirements of the EU Regulations No. 811/2013, No. 812/2013, No. 813/2013 and No. 814/2013 supplementing the Regulation (EU) 2017/1369.

Product data	Symbol	Unit	7 733 600 379	7 733 600 377
Product type	–	–	GR4700iW 15 S NG	GR4700iW 12 S NG
Condensing boiler	–	–	✓	✓
Low temperature boiler	–	–	✗	✗
B1 boiler	–	–	✗	✗
Cogeneration space heater	–	–	✗	✗
Equipped with a supplementary heater?	–	–	–	–
Combination heater	–	–	✗	✗
Rated heat output	P_{rated}	kW	15	12
Seasonal space heating energy efficiency	η_s	%	94	94
Energy Efficiency Class	–	–	A	A
Useful heat output				
At rated heat output and high temperature regime ¹⁾	P_4	kW	15	12
At 30 % of rated heat output and low temperature regime ²⁾	P_1	kW	5.1	4.0
Useful efficiency				
At rated heat output and high temperature regime ¹⁾	η_4	%	88.4	88.5
At 30 % of rated heat output and low temperature regime ²⁾	η_1	%	99.2	99.5
Auxiliary electricity consumption				
At full load	el_{max}	kW	0.031	0.023
At part load	el_{min}	kW	0.011	0.011
In standby mode	P_{SB}	kW	0.002	0.002
Other items				
Standby heat loss	P_{stby}	kW	0.059	0.059
Ignition burner power consumption	P_{ign}	kW	–	–
Emissions of nitrogen oxides (only gas- or oil fired)	NO_x	mg/kWh	34	31
Annual energy consumption	Q_{HE}	kWh	12778	10278
Annual energy consumption	Q_{HE}	GJ	46	37
Sound power level, indoors	L_{WA}	dB	43	42

1) High-temperature regime means 60 °C return temperature at heater inlet and 80 °C feed temperature at heater outlet.

2) Low temperature means for condensing boilers 30 °C, for low-temperature boilers 37 °C and for other heaters 50 °C return temperature (at heater inlet).

Table 11 Product data on energy consumption Greenstar 4000

LPG appliances

The following product data comply with the requirements of the EU Regulations No. 811/2013, No. 812/2013, No. 813/2013 and No. 814/2013 supplementing the Regulation (EU) 2017/1369.

Product data	Symbol	Unit	7 733 600 386	7 733 600 384	7 733 600 382
Product type	–	–	GR4700iW 24 S LPG	GR4700iW 21 S LPG	GR4700iW 18 S LPG
Condensing boiler	–	–	✓	✓	✓
Low temperature boiler	–	–	✗	✗	✗
B1 boiler	–	–	✗	✗	✗
Cogeneration space heater	–	–	✗	✗	✗
Equipped with a supplementary heater?	–	–	–	–	–
Combination heater	–	–	✗	✗	✗
Rated heat output	P_{rated}	kW	24	21	18
Seasonal space heating energy efficiency	η_s	%	94	94	94
Energy Efficiency Class	–	–	A	A	A
Useful heat output					
At rated heat output and high temperature regime ¹⁾	P_4	kW	24	21	18
At 30 % of rated heat output and low temperature regime ²⁾	P_1	kW	8.1	7.1	6.1
Useful efficiency					
At rated heat output and high temperature regime ¹⁾	η_4	%	87.9	88.2	88.1
At 30 % of rated heat output and low temperature regime ²⁾	η_1	%	98.9	99	99.1
Auxiliary electricity consumption					
At full load	e_{max}	kW	0.038	0.030	0.027
At part load	e_{min}	kW	0.012	0.011	0.011
In standby mode	P_{SB}	kW	0.002	0.002	0.002
Other items					
Standby heat loss	P_{stby}	kW	0.059	0.059	0.059
Ignition burner power consumption	P_{ign}	kW	–	–	–
Emissions of nitrogen oxides (only gas- or oil fired)	NO_x	mg/kWh	40	35	37
Annual energy consumption	Q_{HE}	kWh	20556	18056	15287
Annual energy consumption	Q_{HE}	GJ	74	65	55
Sound power level, indoors	L_{WA}	dB	45	44	45

1) High-temperature regime means 60 °C return temperature at heater inlet and 80 °C feed temperature at heater outlet.

2) Low temperature means for condensing boilers 30 °C, for low-temperature boilers 37 °C and for other heaters 50 °C return temperature (at heater inlet).

Table 12 Product data on energy consumption Greenstar 4000

The following product data comply with the requirements of the EU Regulations No. 811/2013, No. 812/2013, No. 813/2013 and No. 814/2013 supplementing the Regulation (EU) 2017/1369.

Product data	Symbol	Unit	7 733 600 380	7 733 600 378
Product type	–	–	GR4700iW 15 S LPG	GR4700iW 12 S LPG
Condensing boiler	–	–	✓	✓
Low temperature boiler	–	–	✗	✗
B1 boiler	–	–	✗	✗
Cogeneration space heater	–	–	✗	✗
Equipped with a supplementary heater?	–	–	–	–
Combination heater	–	–	✗	✗
Rated heat output	P_{rated}	kW	15	12
Seasonal space heating energy efficiency	η_s	%	94	94
Energy Efficiency Class	–	–	A	A
Useful heat output				
At rated heat output and high temperature regime ¹⁾	P_4	kW	15	12
At 30 % of rated heat output and low temperature regime ²⁾	P_1	kW	5.1	4.0
Useful efficiency				
At rated heat output and high temperature regime ¹⁾	η_4	%	88.4	88.5
At 30 % of rated heat output and low temperature regime ²⁾	η_1	%	99.2	99.5
Auxiliary electricity consumption				
At full load	el_{max}	kW	0.031	0.023
At part load	el_{min}	kW	0.011	0.011
In standby mode	P_{SB}	kW	0.002	0.002
Other items				
Standby heat loss	P_{stby}	kW	0.059	0.059
Ignition burner power consumption	P_{ign}	kW	–	–
Emissions of nitrogen oxides (only gas- or oil fired)	NO_x	mg/kWh	34	31
Annual energy consumption	Q_{HE}	kWh	12778	10278
Annual energy consumption	Q_{HE}	GJ	46	37
Sound power level, indoors	L_{WA}	dB	43	42

1) High-temperature regime means 60 °C return temperature at heater inlet and 80 °C feed temperature at heater outlet.

2) Low temperature means for condensing boilers 30 °C, for low-temperature boilers 37 °C and for other heaters 50 °C return temperature (at heater inlet).

Table 13 Product data on energy consumption Greenstar 4000

14 Data Protection Notice



We, **Bosch Thermotechnology Ltd., Cotswold Way, Warndon, Worcester WR4 9SW, United Kingdom**

process product and installation information, technical and connection data, communication data, product registration and client history data to provide product functionality (art. 6 (1) sentence 1 (b)

GDPR), to fulfil our duty of product surveillance and for product safety and security reasons (art. 6 (1) sentence 1 (f) GDPR), to safeguard our rights in connection with warranty and product registration questions (art. 6 (1) sentence 1 (f) GDPR) and to analyze the distribution of our products and to provide individualized information and offers related to the product (art. 6 (1) sentence 1 (f) GDPR). To provide services such as sales and marketing services, contract management, payment handling, programming, data hosting and hotline services we can commission and transfer data to external service providers and/or Bosch affiliated enterprises. In some cases, but only if appropriate data protection is ensured, personal data might be transferred to recipients located outside of the European Economic Area. Further information are provided on request. You can contact our Data Protection Officer under: Data Protection Officer, Information Security and Privacy (C/ISP), Robert Bosch GmbH, Postfach 30 02 20, 70442 Stuttgart, GERMANY.

You have the right to object, on grounds relating to your particular situation or where personal data are processed for direct marketing purposes, at any time to processing of your personal data which is based on art. 6 (1) sentence 1 (f) GDPR. To exercise your rights, please contact us via privacy.ttgb@bosch.com To find further information, please follow the QR-Code.







TECHNICAL SUPPORT: 0330 123 3366
RENEWABLE SUPPORT: 0330 123 9229
CONTROLS AND CONNECTIVITY TEAM: 0330 123 3641
APPOINTMENTS: 0330 123 9339
SPARES: 0330 123 9779
LITERATURE: 0330 123 9119
TRAINING: 0330 123 0166
SALES: 0330 123 9669

Bosch Thermotechnology Ltd.
Cotswold Way, Warndon
Worcester WR4 9SW
United Kingdom
Tel. 0330 123 9559
worcester-bosch.co.uk

 **WORCESTER**

 **BOSCH**